

Article number: 204140M1080D0S

Description: E+G levelling foot
GN 41-40-M10-80-D0-S

Note: S Without nut, External hexagon at the bottom

Measures

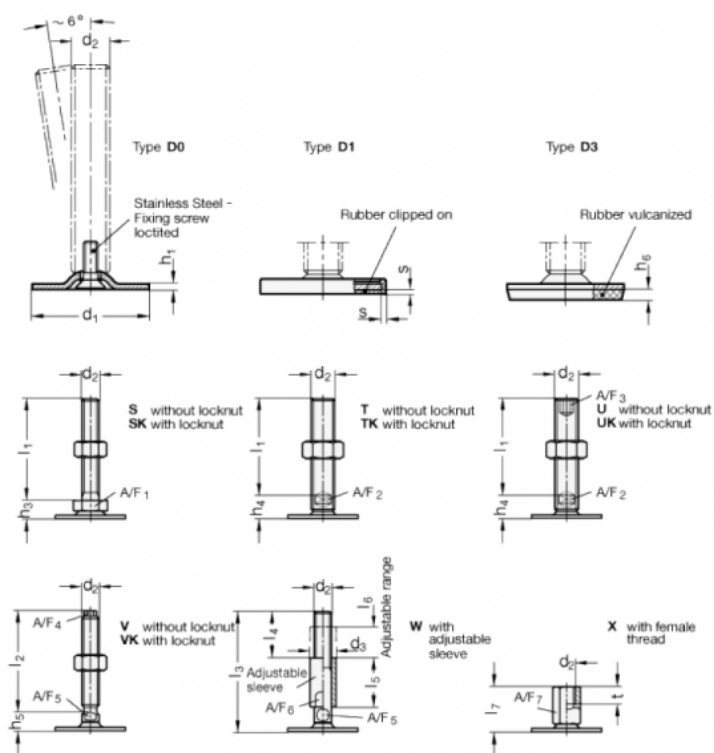

A/F1	= 17
d1	= 40
d2	= M10
h1	= 2
h3	= 11
h6	=
l1	= 80
s	=